

C30R-2B
2365 kg

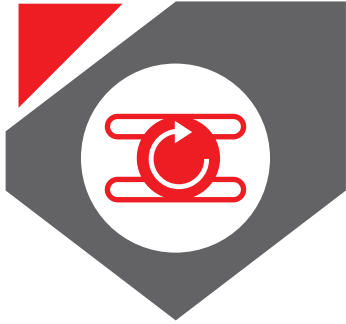

Call for Yanmar solutions





> COMPACTNESS

C30R-2B

The Yanmar C30R-2B is ideal for use on all type of grounds and offers versatility and productivity.

Design principles

- > Compact dimensions:
 - Total width of the machine reduced to 1655 mm.
 - Length of only 3200 mm.
- > Low center of gravity for higher stability.
- > Machine can travel on slopes of up to 30°.



Wide and robust vessel

- > High vessel capacity: 1.24 m³ heaped.
- > Max. payload 2500 kg.
- > Robust vessel with removable gates.

Dumping

- > Ample dumping angle (58°).
- > High ground clearance (415 mm) while dumping.
- > Advantages:
 - Safe dumping.
 - Single dumping stroke.



> HIGH PERFORMANCE

C30R-2B



Combining long experience and unrivalled expertise, YANMAR's technology ensures environmental performance and high efficiency.

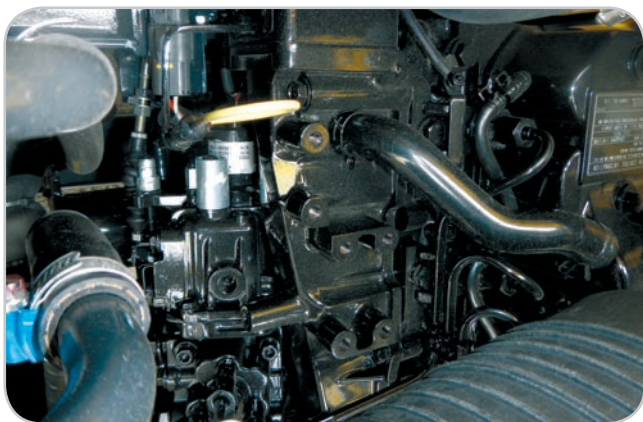

Yanmar "TNV" (Totally New Value) engine



Improvement and modernization of TNE series, which is already well-known for its "clean and quiet" profile:

- > Reduced emissions for an even cleaner engine.
- > Noise reduction for an even quieter engine.
- > Improved starting (warms up faster).

The 3TNV88-BSFW engine exceeds the most stringent emissions standards.

HST transmission

- > Speed change just by pressing the pedal.
- > Smooth and fluid acceleration and deceleration.



Efficiency on all types of terrain

- > Ideal for the use on all grounds: sand, soft and swampy areas, steep slopes...
- > Lower ground pressure due to rubber crawlers and excellent weight distribution: limited ground damage.
- > Rubber crawlers do not damage the asphalt and offer an excellent adhesion on soft grounds.
- > Undercarriage equipped with track rollers with pendular supports to compensate for different ground levels.



> COMFORT

C30R-2B

Full operational comfort for ease of operation and work efficiency.

Access to operating position on both sides of the machine

The reversible seat raises work efficiency on narrow jobsites

- > The operator's seat turns 180°.
- > The machine is always moving forward for the operator.
- > Safer work environment even on mountain paths or other restricted worksites where it is hard to turn the machine.
- > No need to turn the machine to exit the jobsite: reduced damages to environmentally sensitive areas.

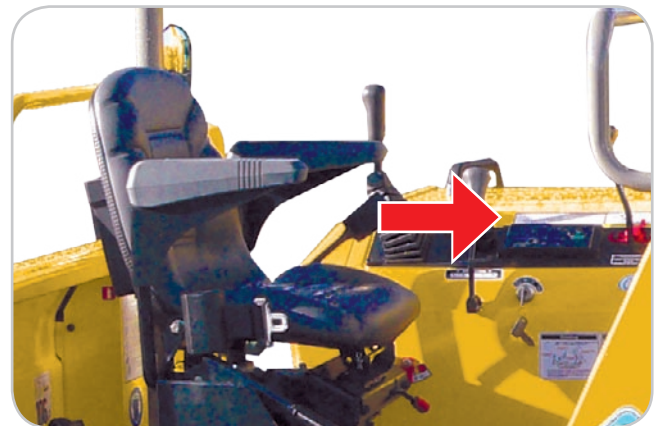

The machine can be single-handedly controlled

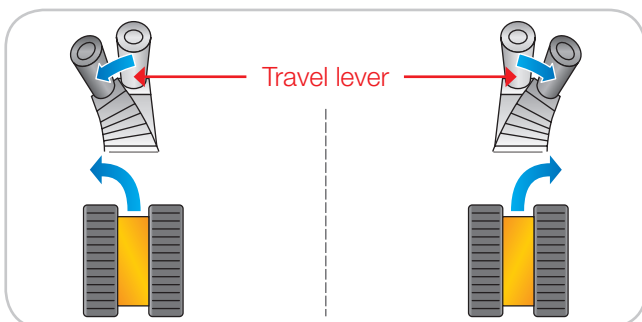

The machine goes according to the orientation of the lever.



- > The only travel lever is very easy to use with a single hand.
- > Safe and ergonomic pilot system: delicate control and long hours of operation easier.

> SAFETY

C30R-2B



- > Seat with retractable seat belt.
- > The reversible seat enhances the security of the operator:
 - During the passage of an obstacle, the operator has to drive the C30R-2B with the load forward.
 - This position enables to stabilize the load and not to tip over while passing the obstacle, which is not possible with a fixed seat.

- > The canopy conforms the ROPS (Roll Over Protective Structure) and FOPS (Falling Object Protective Structure) norms.

Safety bar at the front of the machine and on the top of the vessel for the operator safety during travel on heavy slopes.



- > Wet multiple disk brakes: reliability and durability.
- > Safety system on dumping lever: locks the vessel during travel.



> MAINTENANCE

C30R-2B



Optimum accessibility

- > Large engine hood opening, allowing optimum access to the main engine components.
- > The daily control points (water, engine oil, filters, fan belt...) are positioned to facilitate the maintenance operations.



Robustness of the undercarriage

- > Long undercarriage for better stability.
- > Excellent weight distribution by 6 reinforced track rollers (for each side).



Vessel designed for heavy work

- > The design of the whole structure allows the use of the machine under extreme conditions and increases the machines life.
- > Robust gate levers.

- > The front bumper protects against possible shocks.



TECHNICAL SPECIFICATIONS

C30R-2B



Operating weight +- 2% (EC Norms):
> 2365 kg

Transport weight +-2% (EC Norms):
> 2290 kg

Payload:
> 2500 kg

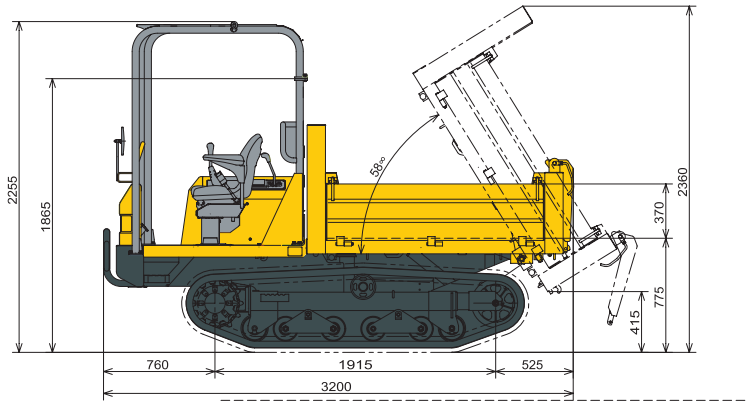
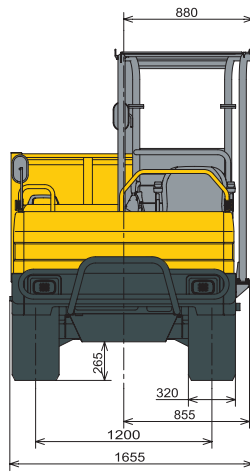
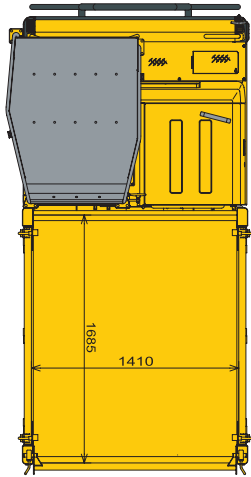

Subject to any technical modifications. Dimensions given in mm.

Yanmar Diesel engine 3 cylinders

Type 3TNV88-BSFW
 Rated Output 19.2 kw / 26.1 HP / 2200 rpm
 Displacement 1642 cm³
 Cooling system..... Water
 Max. torque..... 106.7 N.m. / 1320 rpm

Undercarriage

Track width..... 320 mm
 Min. ground clearance..... 265 mm
 Ground pressure (unloaded) 0.27 kg/cm²
 Ground pressure (loaded) 0.57 kg/cm²

Performance

Max. Payload 2500 kg
 Dumping angle..... 58°
 Vessel dimensions (L x W x H) 1685 x 1410 x 370 mm
 Dumping mechanism 1 side
 Dump clearance..... 415 mm
 Dump vessel capacity (struck / heaped) 0.88 / 1.24 m³
 Grade ability 30°
 Max. Travelling speed (forward)..... 0 – 8.2 km/h
 Max. Travelling speed (reverse) 0 – 8.2 km/h

Miscellaneous

Transmission Hydraulic engine with gear
 Hydraulic tank 13 l
 Hydraulic system 18 l
 Fuel tank 40 l
 Brake Wet multiple disk brake
 Noise level LwA (2000/14/EC & 2005/88/EC) 106 dBA



Printed in France – Materials and specifications are subject to change from the manufacturer without notice. Please contact your local Yanmar Construction Equipment Europe dealer for further information.

Yanmar Construction Equipment Europe S.A.S.

25, rue de la Tambourine
52100 SAINT DIZIER – FRANCE
contact@yanmar.fr

www.yanmar.eu